



Summit Amplifier Reference Design

Bridged 30-Watt Amplifier with Integrated SMPS

HARDWARE PRODUCT BRIEF

Amplifier Description

The Summit 30-watt amplifier is a reference design intended to facilitate the development of wireless speakers for home theater systems. It is designed specifically for consumer electronics products that integrate Summit Wireless technology, and is optimized for bookshelf speakers and high-quality performance. The amplifier includes a universal switching-mode power supply (SMPS) that supports 100 to 240VAC, at 50 or 60Hz, and can be applied as a single channel, 30-watt mono amplifier, or as a two-channel stereo amplifier that supplies 15 watts per channel.

Amplifier Features:

- Integrated SMPS, supporting 100-240VAC @ 50/60Hz
- Easily configurable for 2x15W or 1x30W operation (<0.3% THD +N%)
- Integrated Ultrasonic Circuitry for surround speakers (SpeakerFinder™ and MyZone™ support)
- Three Status LEDs – System Heartbeat, Network Link, Amp Error/Sleep
- Designed to meet UL Safety Specifications
- Designed to pass FCC Part 15 Emissions Requirements
- Designed to pass DFS Requirements when used with Summit Receiver Module
- WiSA compliant

The amplifier is designed for use with the Summit Wireless Receiver Module (SKU 444-2250), and supports WiSA interoperability. Working samples that are fully configured for a surround speaker application, with an aluminum back plate and a Summit Receiver Module, are available. The back plate includes a power cord connector (IEC60320-C7), a service port for firmware updates, a Reset button, and a window for the three-LED status indicator array.

The reference design amplifier is based on the Texas Instruments TAS5727 amplifier. It can be easily configured to provide mono output, supporting 1x30W output to a 4Ω or 6 Ω load, or stereo output, supporting 2x15W output to 8Ω loads. The crossover network and speaker equalization is performed completely digitally in the Summit Wireless Receiver ASIC, eliminating the need for passive components.

Reference Design Contents:

A complete Reference Design is available from Summit Wireless. Reference Design contents include:

- Schematics in Adobe PDF or Altium formats.
- Bill of Material in Microsoft Excel format
- Gerber files (4 layer board)
- 3D CAD files (.STEP) files for aluminum back plate and modules
- Amplifier configuration firmware (for PIC processor)



Summit Amplifier Reference Design

Bridged 30-Watt Amplifier with Integrated SMPS

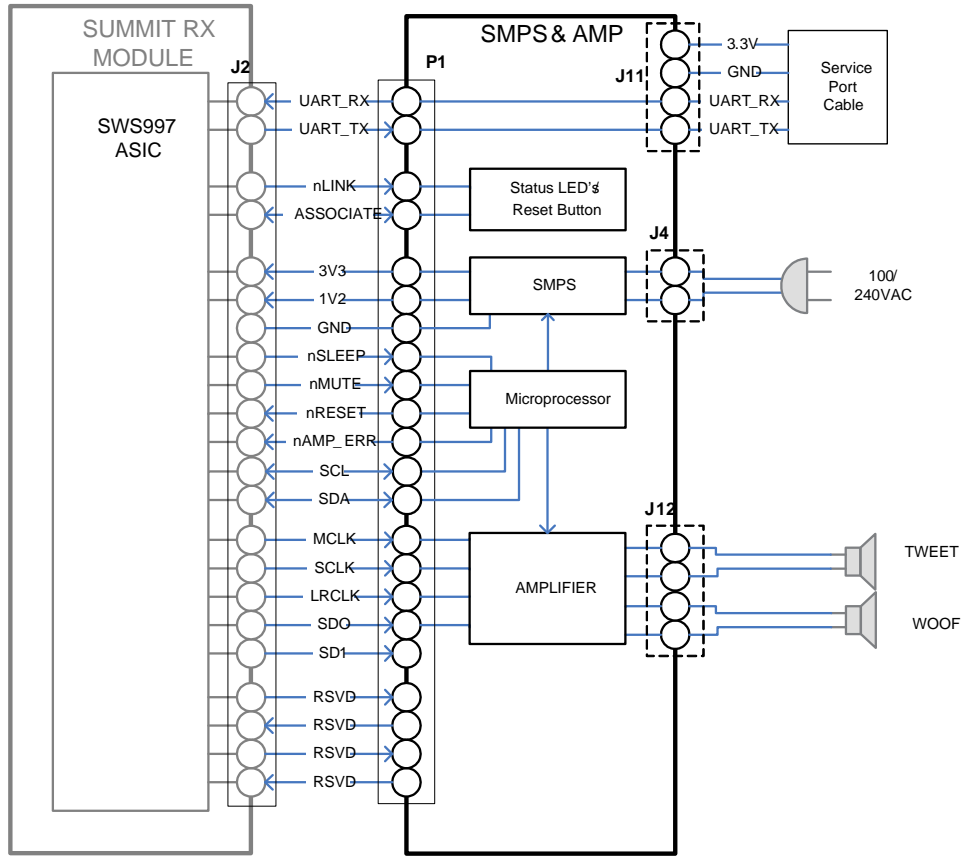

Summit Speaker System Block Diagram

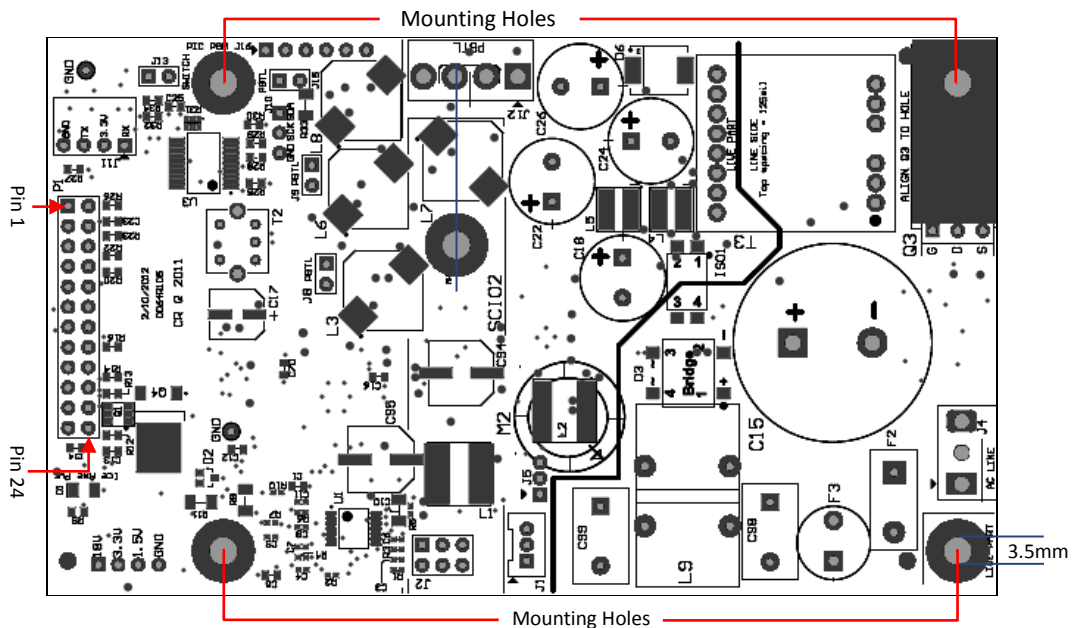

Amplifier Assembly Diagram (Reference Design)

Performance Characteristics

PARAMETER	SYMBOL	TEST CONDITIONS	MIN	TYP	MAX	UNIT
Power Output Per Speaker	P _O	Bridged mode continuous - 4 or 6-ohm load		30		W
		Stereo mode continuous – 8-ohm load		15		W
Total Harmonic Distortion + Noise	THD+N%	Bridged mode continuous - 4 or 6-ohm load - 27W			0.3%	%
		Stereo mode continuous – 8-ohm load - 15W			0.3%	%
Audio Sample Rate					48	KHz
Crosstalk		Stereo mode - 8 ohm load - 1W - 20 to 20KHz			-50	dB
Signal-to-Noise Ratio	SNR				100	dB
Noise Floor					-100	dBV
Line Voltage Input			100		240	VAC
Line Voltage Frequency			50		60	Hz
Operating Temperature	T _a		0		70	°C

Audio Characteristics:

The amplifier reference design exhibits the following operational audio characteristics.

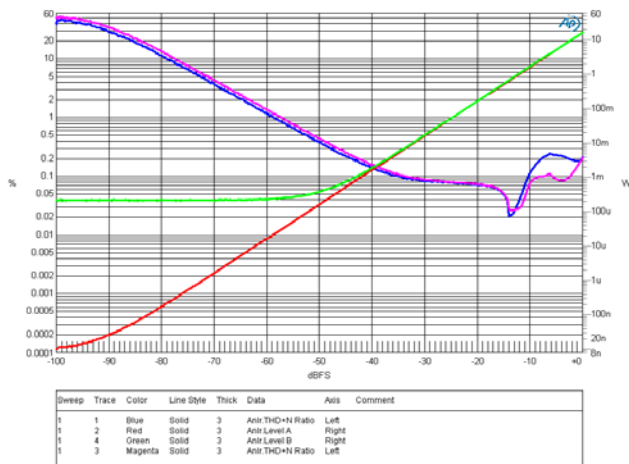

BTL (stereo) THD+N% vs. output power

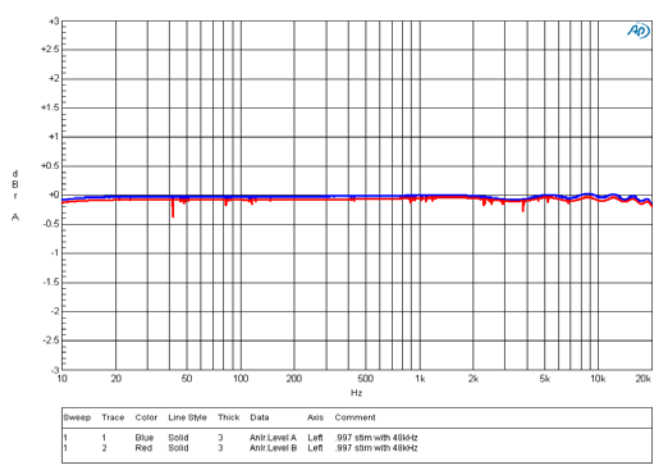

BTL Frequency Response

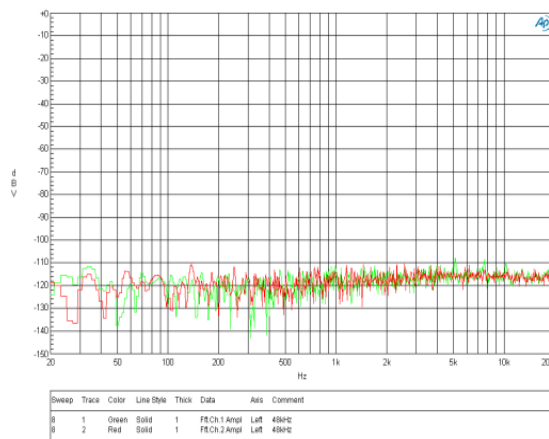

BTL Noise Floor

Critical Dimensions

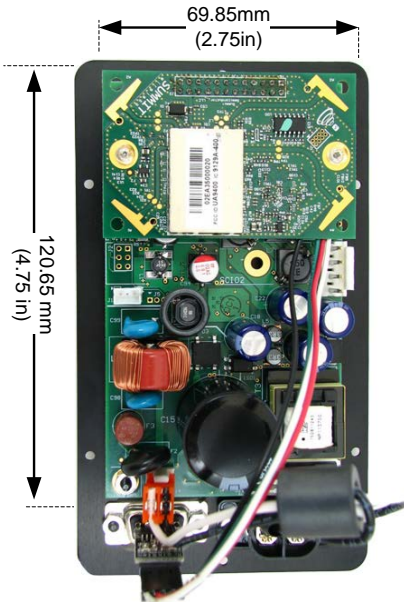

Amp View (amplifier dimensions)



Side View (component height)

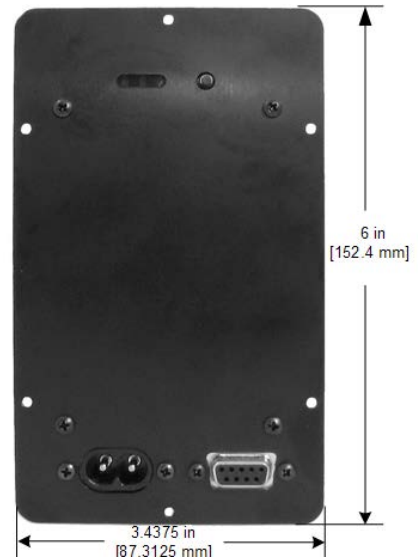

Back View (back plate dimensions)

Ordering Information (Sample)

SUMMIT SKU	PART DESCRIPTION
444-2218	Summit 30W 2-Way Class D Amplifier w/ Backplate and Summit Rx Module.
444-2221	Summit 30W 2-Way Class D Amplifier Center w/ Backplate and Summit Rx Module